

Sage® by Heston Blumenthal®

Freephone (UK Landline): 0808 178 1650
Mobile Calls (National Rate): 0333 0142 970

www.sageappliances.co.uk
customerservice@sageappliances.co.uk

Register your product and get more from your purchase

Product registration takes only a few minutes and ensures a record of your purchase. Registration also makes it easier to get support and advice on any questions or issues that you might have in the future. If you wish, we can also send you free recipes and additional hints and tips on making the best of your appliance.

➤ Go to www.sageappliances.co.uk and click on 'Product Registration'.

What's on your mind?

Our constant aim is to improve the quality and features of our appliances. We welcome your comments and ideas in assisting our ongoing development.

➤ Go to www.sageappliances.co.uk and click on 'Support'.

BONUS

Receive 3 free filters when you register your product for a year of protection.*

claro
by SWISS

For registration visit filter.sageappliances.co.uk

* Sage will deliver 1 free filter at each of the following intervals, 3 months, 6 months and 9 months after the date of purchase.



Sage by heston
blumenthal

Registered in England & Wales No. 8223512. Due to continued product improvement, the products illustrated or photographed in this document may vary slightly from the actual product.

Copyright BRG Appliances 2016.

SES990 UK - B17

the Oracle™ Touch

Instruction Book - SES990



Sage by heston
blumenthal



Contents

- 2 Important Safety Information
- 7 Components
- 10 Assembly
- 11 Functions
- 17 Tips
- 19 Care & Cleaning
- 23 Troubleshooting

SAGE RECOMMENDS SAFETY FIRST

At Sage® by Heston Blumenthal® we are very safety conscious. We design and manufacture consumer products with the safety of you, our valued customer, foremost in mind. In addition we ask that you exercise a degree of care when using any electrical appliance and adhere to the following precautions.

IMPORTANT SAFEGUARDS

READ ALL INSTRUCTIONS BEFORE USE AND SAVE FOR FUTURE REFERENCE

- Before using for the first time please ensure that your electricity supply is the same as shown on the rating label on the underside of the appliance. If you have any concerns please contact your local electricity company.
- Your Sage® by Heston Blumenthal® appliance includes a BS 13 amp moulded mains plug on the supply cord.
- Should you need to change this plug, please complete the rewiring as follows (after safe disposal of the moulded plug).
- Please note that a cut off plug inserted into a socket is a serious danger risk.

- Wires are coloured as follows:
 - Blue = Neutral
 - Brown = Live
- As the colours of the wire may not correspond with the coloured markings which identify the terminals in your plug, please refer to the following:
 - The Blue wire must be connected to the terminal which is marked ‘N’
 - The Brown wire must be connected to the terminal which is marked with the letter ‘L’.
- Please note that if a 13 amp plug is used, a 13 amp fuse should be used.
- Remove any packaging material and promotional labels or stickers before using the Oracle™ Touch for the first time.
- To eliminate a choking hazard for young children, remove and safely discard the protective cover fitted to the power plug of this appliance.
- Do not place the product near the edge of a bench or table during operation. Ensure the surface is level, clean and free of water and other substances.
- Do not let the cord hang over the edge of a bench or table, or become knotted. Keep away from hot gas or electric burner, or where it could touch a heated oven.
- This appliance can be used by children aged from 8 years and above if they have been given supervision or instruction concerning use of the appliance in a safe way and understand the hazards involved.

Cleaning and user maintenance shall not be made by children unless they are aged from 8 years and above and supervised. Keep the appliance and its cord out of reach of children aged less than 8 years.



- Appliances can be used by persons with reduced physical, sensory or mental capabilities or lack of experience and knowledge if they have been given supervision or instruction concerning use of the appliance in a safe way and understand the hazards involved.
- Children shall not play with the appliance.

- Regularly inspect the supply cord, plug and actual appliance for any damage. If found damaged in any way, immediately cease use of the appliance and return the entire appliance to the nearest authorised Sage Service Centre for examination, replacement or repair.
- Keep the appliance and accessories clean. Follow the cleaning instructions provided in this book. Any procedure not listed in this instruction booklet should be performed at an authorised Sage Service Centre.
- The installation of a residual current device (safety switch) is recommended to provide additional safety protection when using electrical appliances. It is advisable that a safety switch with a rated residual operating current not exceeding 30mA be installed in the electrical circuit supplying the appliance. See your electrician for professional advice.

SPECIFIC INSTRUCTIONS FOR SES990 THE ORACLE™ TOUCH

- This appliance is recommended for household use only. Do not use this appliance for any purpose other than its intended use. Do not use in moving vehicles or boats. Do not use outdoors.
- If the appliance is to be:
 - left unattended
 - cleaned
 - moved
 - assembled; or
 - stored
- Always switch Off the espresso machine by pressing the Power button to Off, switch Off at the power outlet and unplug.
- Ensure the product is properly assembled before first use.
- Do not use any other liquid apart from cold mains/town water. We do not recommend the use of highly filtered, demineralised or distilled water as this may affect the taste of the coffee and how the espresso machine is designed to function.
- Ensure the portafilter is firmly inserted and secured into the group head before starting an extraction. Never remove the portafilter during the extraction process.
- Do not touch hot surfaces. Allow the product to cool down before moving or cleaning any parts.
- Use caution after milk texturing as the 'Auto Purge' function may purge hot steam when the steam wand is lowered.
- Use caution when operating machine as metal surfaces are liable to get hot during use.

- Use caution when using the de-scale feature as hot steam may be released. Before de-scaling, ensure drip tray is empty and inserted. Refer to page 22 for further instructions.

-  The symbol shown indicates that this  appliance should not be disposed of in normal household waste. It should be taken to a local authority waste collection centre designated for this purpose or to a dealer providing this service. For more information, please contact your local council office.

SPECIFIC INSTRUCTIONS FOR WATER FILTER

- Filter cartridge should be kept out of reach of children.
- Store filter cartridges in a dry place in the original packaging.
- Protect cartridges from heat and direct sunlight.
- Do not use damaged filter cartridges.
- Do not open filter cartridges.
- If you are absent for a prolonged period of time, empty the water tank and replace the cartridge

FOR HOUSEHOLD USE ONLY
SAVE THESE INSTRUCTIONS



Components

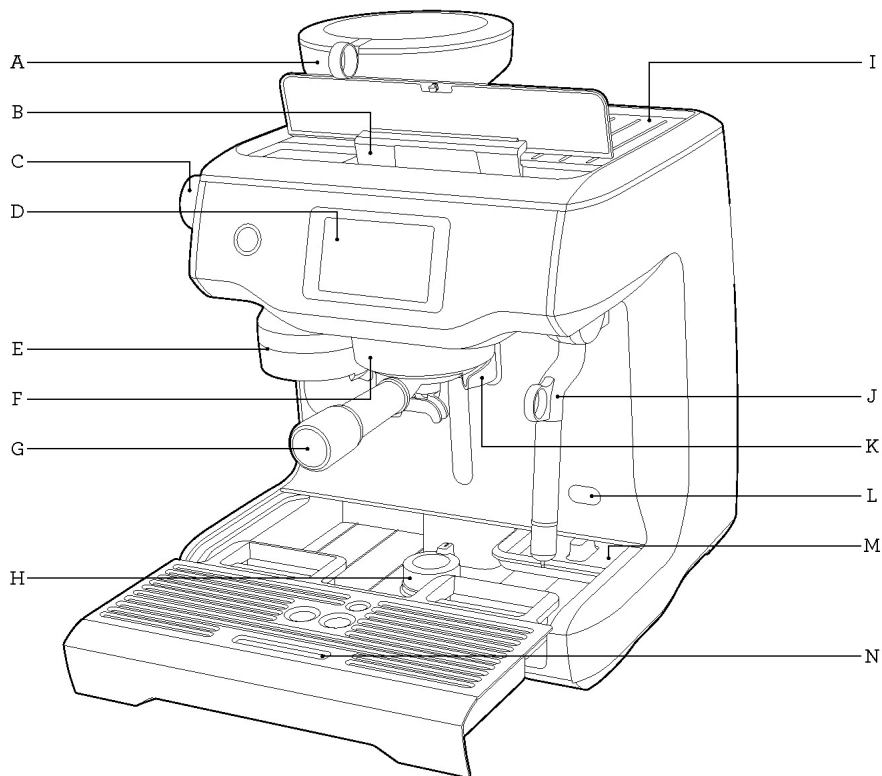

- A. Integrated conical burr grinder**
With removable 280g bean hopper.
- B. Top-fill 2.5L removable water tank**
With integrated water filter and backlit level indicator.
- C. Grind size dial**
Adjust grind size to suit your coffee beans.
- D. Touch screen control panel**
Displays current settings and provides touch interface.
- E. Grind outlet**
With auto grind, dose & tamp function.
- F. Heated 58mm group head with embedded element**
- G. 58mm full stainless steel portafilter**
- H. Drop down swivel foot**
Lifts the machine upwards for easy manoeuvrability.
- I. Heated cup warming tray**
- J. Cool touch steam wand**
With integrated temperature sensor.
- K. Dedicated hot water outlet**
Delivers hot water for Long Black and pre-heating cups.
- L. Descale access point**
- M. Tool storage tray**
Houses accessories when not in use.
- N. Removable drip tray**
With Empty Me! indicator.

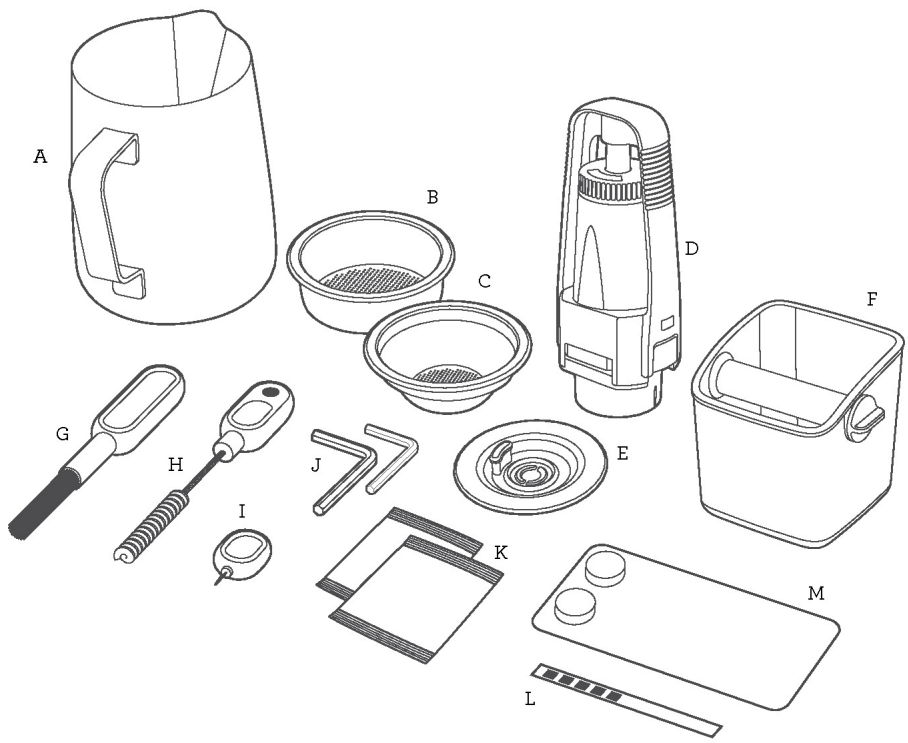

ACCESSORIES

- A. Stainless steel milk jug
- B. 2 cup filter basket
- C. 1 cup filter basket
- D. Water filter holder with filter
- E. Cleaning disc
- F. Mini grinds bin
- G. Grinder burr brush
- H. Grind outlet brush & tamp removal magnet
- I. Cleaning tool for steam wand tip
- J. Two allen keys
- K. Steam wand cleaning powder
- L. Water hardness test strip
- M. Espresso cleaning tablets



Oracle™ Touch Features

COLOUR TOUCH SCREEN CONTROL PANEL

Swipe & Select from the drinks menu. Adjust your coffee strength, milk texture or milk temperature, then save it as your personal favourite.

HANDS FREE AUTOMATIC GRIND, DOSE & TAMP

Automatically grinds, doses and tamps the required amount of coffee, mess free.

GRIND SIZE DIAL

Adjustable grind settings from fine to coarse for optimal espresso extraction.

STAINLESS STEEL CONICAL BURRS

Maximise ground coffee surface area for a full espresso flavour.

AUTOMATIC HANDS FREE MILK TEXTURING

Automatically textures milk to the selected temperature and style from silky smooth latté to creamy cappuccino. Automatic purge removes residual milk from the steam wand when returned to the downward position.

SIMULTANEOUS COFFEE & STEAM

Dedicated stainless steel espresso and steam boilers for simultaneous milk texturing and espresso extraction.

PRECISION CONTROL

Electronic PID Temperature Control

Electronic temperature control delivers precise water temperature for optimum espresso flavour.

Actively Heated Group Head

Commercial size 58mm group head with embedded element for thermal stability during extraction.

Regulated Extraction Pressure

Over pressure valve (OPV) limits maximum pressure for optimal espresso flavour.

Low Pressure Pre-Infusion

Gradually increases water pressure to gently expand grinds for an even extraction.

Dual Pumps

Dedicated Italian made espresso and steam boiler pumps.

Programmable Shot Temperature

Adjust water temperature to achieve optimal espresso flavour depending on coffee origin and degree of roast.

ADDITIONAL FEATURES

Auto Start

Switches machine on at a specified time.

Auto Off

Switches machine off after 30 minutes.



Assembly

BEFORE FIRST USE

Machine Preparation

Remove and discard all labels and packaging materials attached to your espresso machine. Ensure you have removed all parts and accessories before discarding the packaging.

Remove the packaging and the plastics bags containing the water filter and water filter holder. Clean parts and accessories (water tank, portafilter, filter basket, jug) using warm water and a gentle dish washing liquid. Rinse well then dry thoroughly.



TIP

To easily manoeuvre your machine, use the drop down swivel foot located under the drip tray. When turned to UNLOCK, the swivel foot drops down & lifts the machine upwards, making it easier to access the removable water tank or reposition the machine to another location.

INSTALLING THE WATER FILTER

- Remove the water filter and water filter holder from the plastic bag.
- Wash the filter holder with cold water.

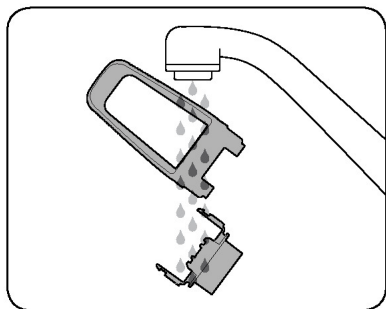

- Set the reminder for next month of replacement. We recommend to replace the filter after 3 months.

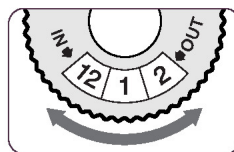

- Insert the filter into the two parts of the filter holder.

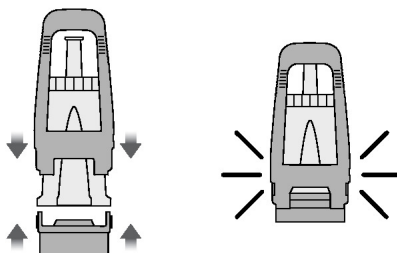

- To install the assembled filter holder into the water tank, align the base of the filter holder with the adapter inside the water tank. Push down to lock into place.
- Fill the water tank with cold water before sliding back into position at the back of the machine and locking into place.

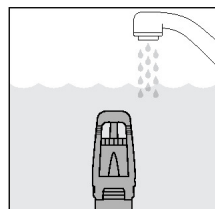
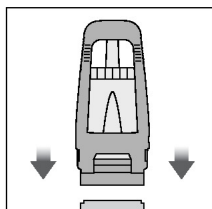

NOTE

If you replace the filter every 3 months or 40 litre use, you don't have to descale the machine. Filter can be purchased at Sage webpage.



NOTE

DO NOT use highly filtered, demineralised or distilled water in this machine. This may affect the taste of the coffee and how the machine operates.



Functions

FIRST USE

1. Press POWER button to turn the machine on.
2. Follow the instructions on screen to guide you through first use setup.
3. After completing setup, the machine will tell that it is ready to use.

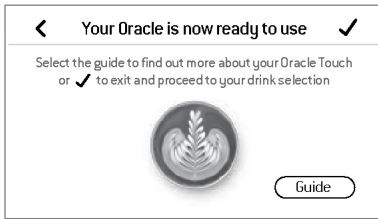

The machine is now in STANDBY mode.

4. Touch "Guide" and the machine will guide you step by step to make your first coffee. Touch the tick and go to the Drinks Menu or < to repeat the Setup. To repeat the Guide at any time, go to Settings Menu.



NOTE

If your water hardness is either 4 or 5 when tested, we strongly recommend you change to an alternate water source.

Filtered, bottled spring or mineral water will extend both the life of your built-in filter and descale intervals as well as superior taste. Please ensure to test the water hardness of the alternative water source you've chosen and input into the machine accordingly. Avoid using overly filtered water, like RO water unless some mineral content is being added back to the final water. Never use distilled water, or water with no or low mineral content as this will affect both the taste and the functioning of your machine.

GRINDING OPERATION

Insert bean hopper into position on-top of the machine. Turn dial to lock into place. Fill hopper with fresh beans.

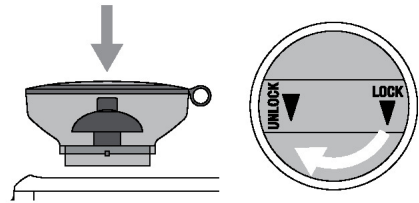

TIP

We recommend quality 100% Arabica beans with a 'Roasted On' date stamped on the bag, not a 'Best Before' or 'Use By' date. Coffee beans are best consumed between 5-20 days after the 'Roasted On' date. Stale coffee may pour too quickly from the portafilter spouts and taste bitter and watery.

DRINK SELECTION

To enter Drinks Menu screen, touch the Home icon . Swipe & select your drink. Touch the 'Help & Tip' icon **i** to see Oracle™ Touch Guide.



NOTE

Please keep the touch screen dry and clean to ensure that the machine functions properly.

DRINK SCREEN

In this screen, you can adjust your drink by touching the oval shaped buttons. You cannot adjust the Grind Size by touching the button, use the dial on the side of the machine.

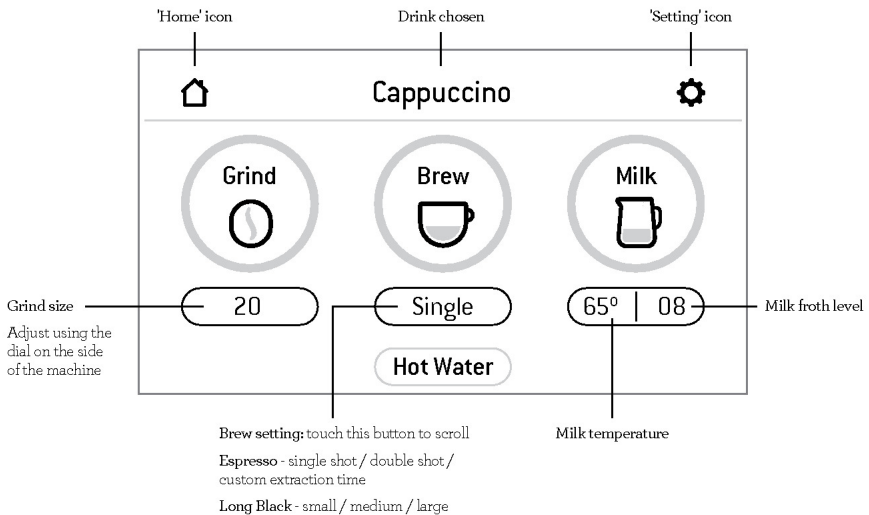

SELECTING GRIND SIZE

We recommend you start at No. 30 and adjust as required to control espresso flow rate.

There are 45 grind size settings (No.1 - finest, No. 45 - coarsest) to enable you to select the right grind size for your coffee beans and achieve the perfect espresso extraction.

To select grind size, rotate the grind size dial counter-clockwise to increase grind coarseness or clockwise to increase grind fineness.

SELECTING YOUR FILTER BASKET

Insert the correct Filter Basket into the Portafilter for the number of coffees or strength you are making.

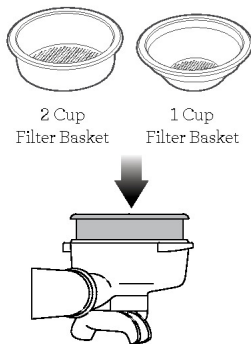

Use the 1 Cup Filter Basket for making a single cup or a weaker tasting espresso.

Use the 2 Cup Filter Basket for making 2 cups or a stronger tasting espresso, usually for mugs or larger cups.



When switching between the 1 Cup & 2 Cup Filter Baskets, you may need to adjust the grind size to fine tune your extraction.

AUTO GRIND DOSE & TAMP

Align portafilter handle with the INSERT position on the grind outlet. Lift to insert portafilter into the grind outlet and rotate to the center position.

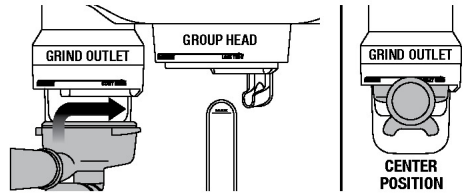

To start the auto grind, dose & tamp function, touch the Grind button on the display. Grinding will commence.

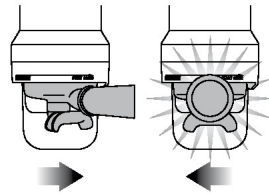

When the auto grind, dose & tamp function is complete, rotate the portafilter handle to the INSERT position and lower to remove.

ESPRESSO EXTRACTION

Align portafilter handle with the INSERT position on the group head. Lift to insert portafilter into the group head and rotate towards the LOCK TIGHT position until resistance is felt.

Touch the 'Brew' button on the display to start extraction. You can switch between single shot, double shot or Custom by touching the 'Single', 'Double' or Custom button. The duration times are preset, but can be customised.

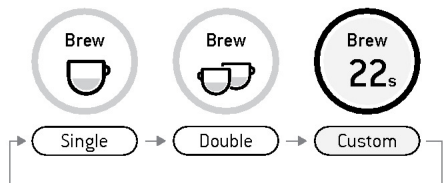

MANUAL OVERRIDE

Press and hold the 'Brew' button (approx 2secs) to enter manual extraction mode. Touch the Brew button to start the extraction, touch the Brew button to stop the extraction.

TEXTURING MILK

Different brands and types of milk and milk alternatives will texture differently. You may need to adjust the froth level accordingly.

Start with fresh cold milk. Fill milk jug to below the spout position. Lift steam wand and insert into milk jug. Lower steam wand, ensuring it is fully down. The milk jug should rest on the drip tray and milk should cover the steam wand seal.

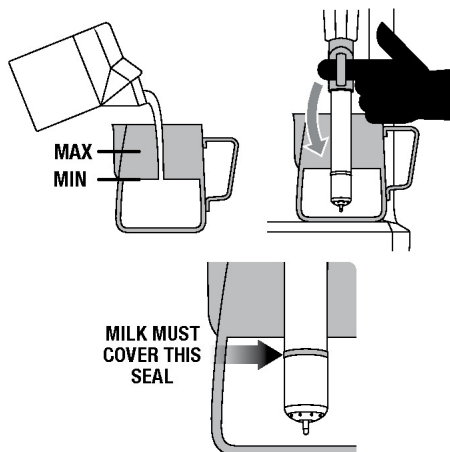

To start, touch the 'Milk' button. The screen will display the temperature of the milk as it heats. Milk texturing will stop automatically when the selected milk temperature is reached. Lift steam wand to remove milk jug. **Wipe the wand & tip with a clean damp cloth.** Lower steam wand to the down position and the wand will automatically purge.

NOTE

Prior to texturing milk, it is recommended to momentarily purge the steam wand by first touching the 'Milk' button. Touching the button again will stop steam delivery.

MANUAL MILK TEXTURING

Auto milk texturing and auto shut-off are disabled during manual milk texturing mode.

Lift the steam wand. Press and hold the 'Milk' Button (approx 2secs) to enter manual mode. Start frothing by touching the button.

When desired temperature is reached, touch the Milk Button to stop.

Wipe the wand & tip with a clean damp cloth. Lower steam wand to the down position and the wand will automatically purge.

CAUTION: BURN HAZARD

Pressurised steam can still be released, even after machine has been switched off.

Children must always be supervised.

LONG BLACK

There are 3 preset Long Black settings – small, medium and large.

Grind dose & tamp your porta-filter & insert into the group head. Position your cup underneath the porta-filter spouts & the hot water spout. Espresso will be extracted first, the hot water is delivered automatically after the espresso.

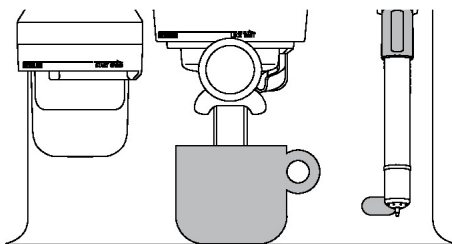

PRESET CUP SIZE	AMOUNT BREWED
Small	Approx. 6oz / 180ml
Medium	Approx. 8oz / 240ml
Large	Approx. 12oz / 360ml

The brewed amounts are approximate only. Actual amounts may vary due to the coffee bean roast, blend and freshness as well as the selected grind size. These factors affect extraction rate and shot volume.

HOT WATER

The HOT WATER function can be used to pre-heat cups or add hot water manually.

To start & stop hot water, touch 'Hot Water' on the screen.

To ensure water is dispensed at the correct temperature, hot water will cease to dispense after approx. 30 seconds. Depending on the size of your cup, you may need to touch the 'Hot Water' button to stop pouring.



NOTE

You cannot run hot water and extract espresso at the same time.

ADDING NEW DRINK

Touch 'Create New' in the menu screen to create a customised drink. You can adjust parameters based on a standard style and save your own.



Add New

Alternatively, after manually adjusting parameters touch the small icon  to save the current setting.

SETTINGS

To enter settings menu, touch the icon  on the upper right on the screen.

Quick Start Guide

Machine will guide you on screen, step by step to make an actual coffee.

Auto Start

Auto Start is optional. It allows you to program the specific time when the machine will automatically turn on.

Time and Date

Time and Date is optional. You can set time and date.

Clean Cycle

The Cleaning Cycle cleans the shower screen and back-flushes the group head.

A pop-up message will let you know when it is time for cleaning.

Descal Cycle

Descaling prevents excess mineral and scale build-up. A pop-up message will let you know when it is time for descaling.

Brew Temperature

It allows you to adjust the recommended extraction temperature.

Default Milk Temperature

It allows you to adjust default temperature on all milk base drinks.

Water Hardness

It is to test water to set how often you need to descale the machine.

Screen Brightness

You can adjust brightness of your touch screen.

Work Light Brightness

You can adjust brightness of your work light.

Sound Volume

You can adjust volume for alerts and reminders.

Demo Mode

It is for on-screen Oracle™ demonstration sequence.

Factory Reset

Use this function to reset all programmable values back to the factory settings and delete all custom drinks.

TRANSPORTING AND STORING

We recommend draining both boilers completely before transporting the machine or storing for an extended period of time. Refer to the Descale section for the step by step instructions.

This procedure is also intended as an anti-freeze measure in the event the machine is exposed to extreme cold temperatures.

ADJUSTING CONICAL BURRS

Some types of coffee may require a wider grind range to achieve an ideal extraction or brew. A feature of the built-in grinder is the ability to extend this range with an adjustable upper burr. We recommend making only one adjustment at a time.



Unlock hopper

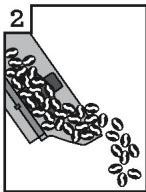

Remove beans



Replace & lock hopper

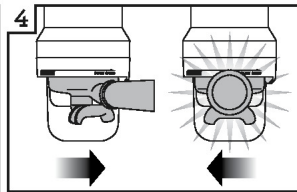

Run grinder until empty

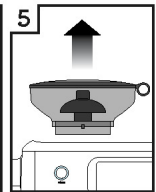

Unlock & remove hopper



Remove upper burr

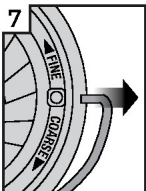

Remove wire handle from both sides of the burr

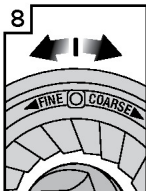

Move adjustable top burr, 1 number, coarser or finer

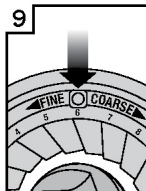

Align the number with the handle opening

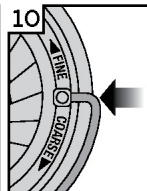

Insert wire handle from both sides of the burr

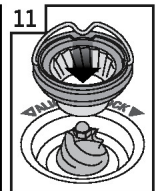

Push upper burr firmly into position



Lock upper burr

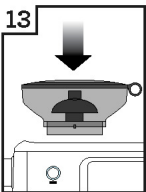

Insert hopper



Lock hopper



Tips

PRE-HEATING

Heating your cup or glass

A warm cup will help maintain the coffee's optimal temperature. Pre-heat your cup by rinsing with hot water from the hot water outlet and place on the cup warming tray.

Heating the portafilter and filter basket

A cold portafilter and filter basket can reduce the extraction temperature enough to significantly affect the quality of your espresso. Always ensure the portafilter and filter basket are pre-heated with hot water from the hot water outlet before initial use.



NOTE

Always wipe the filter basket and portafilter dry before dosing with ground coffee as moisture can encourage 'channeling' where water by-passes the ground coffee during extraction.

THE GRIND

When grinding coffee beans for espresso, the grind size should be fine but not too fine. The grind size will affect the rate at which the water flows through the ground coffee in the filter basket and the taste of the espresso.

If the grind is too fine (looks like powder and feels like flour when rubbed between fingers), the water will not flow through the coffee even when under pressure. The resulting espresso will be **OVER-EXTRACTED**, dark in colour and bitter in flavour.

If the grind is too coarse the water will flow through the ground coffee in the filter basket too quickly. The resulting espresso will be **UNDER-EXTRACTED**, lacking in colour and flavour.

AUTOMATIC GRINDING, DOSING & TAMPING

- Ensure hopper is filled with fresh coffee beans. Never put pre-ground coffee in the hopper.
- After automatic grinding, dosing & tamping, wipe any excess coffee from the rim of the filter basket to ensure a proper seal in the group head is achieved.
- To adjust tamping height, please use the allen key provided. Pull the tamping fan down from the grind outlet, and then loosen the fan coupling inside by rotating it counterclockwise. You can adjust the length of the coupling by loosening the fastener with the allen key and rotating the coupling to the desired length.

PURGING THE GROUP HEAD

Before placing the portafilter into the group head, run a short flow of water through the group head by touching the 'Brew' button. Allow water to flow for 5 seconds, then touch the 'Brewing' button again to stop the flow of water. This will purge any ground coffee residue from the group head and stabilise the water temperature prior to extraction.

EXTRACTING ESPRESSO

- As a guide, the espresso will start to flow within 8-12 seconds (this includes pre-infusion time) and should be the consistency of warm dripping honey.
- If the espresso starts to flow before 8 seconds, the grind is too coarse. This is an **UNDER-EXTRACTED** shot. Adjust the grind size slightly finer.
- If the espresso starts to flow after 12 seconds, then the grind is too fine. This is an **OVER-EXTRACTED** shot. Adjust the grind size slightly coarser.

A great espresso is about achieving the perfect balance between sweetness, acidity and bitterness.

The flavour of your coffee will depend on many factors, such as the type of coffee beans, degree of roast, freshness, coarseness or fineness of the grind.

Experiment by adjusting these factors just one at a time to achieve the taste of your preference.

EXTRACTION GUIDE

EXTRACTION TYPES	GRIND	SHOT DURATION
OVER-EXTRACTED (bitter • astringent)	Too Fine	Over 40secs
BALANCED	Optimum	Between 25-35secs
UNDER-EXTRACTED (underdeveloped • sour)	Too Coarse	Less than 20secs



HINTS & TIPS

If machine is run continuously for 30 minutes, allow machine to cool for 3 minutes before each use.

TEXTURING MILK

- Always start with fresh cold milk.
- Fill milk jug to below the spout position. At a minimum, there should be enough milk to cover the steam wand seal.
- To remove any condensed water from the system, ensure the steam wand is in the down position over the drip tray then touch the Milk button, allow steam to flow for a few seconds, then touch the Milk button to stop.
- When texturing milk automatically, ensure the steam wand is fully down.



HINTS & TIPS

For optimum milk texturing performance it is critical that the holes around the steam tip are clear. Even partially blocked holes may affect the ability of the steam wand to produce sufficient foam.

Always wipe the wand and tip with a damp cloth BEFORE returning the wand to the down position. Wiping the wand will remove the majority of milk and allow the automatic purge feature to more effectively remove any residual milk.

After texturing is complete

- Tap the jug on the counter-top to collapse any bubbles.
- Swirl the jug to polish and re-integrate the texture.
- Pour milk directly into the espresso.
- The key is to work quickly, before the milk begins to separate.

For manual texturing,

- Lift the steam wand and insert the steam tip 1-2cm below the surface of the milk close to the right hand side of the jug at the 3 o'clock position. Enter manual frothing mode by pressing and holding the 'Milk' button (approx 2secs), and then start frothing by touching the button.
- Keep the tip just under the surface of the milk until the milk is spinning clockwise, producing a vortex (whirlpool effect).
- With the milk spinning, slowly lower the jug. This will bring the steam tip to the surface of the milk & start to introduce air into the milk. You may have to gently break the surface of the milk with the tip to get the milk spinning fast enough.
- Keep the tip at or slightly below the surface, continuing to maintain the vortex. Texture the milk until sufficient volume is obtained.
- Lift the handle of the jug to lower the tip beneath the surface, but keep the vortex of milk spinning. Use the touch screen to monitor the milk temperature. We recommend 55°C-65°C.
- Touch the Milk button to stop steaming BEFORE lowering the jug and taking the tip out of the milk.

COFFEE BEAN HINTS & TIPS

- Fresh, quality coffee beans will give you the best possible extraction.
- We recommend quality 100% Arabica beans with a 'Roasted On' date stamped on the bag, not a 'Best Before' or 'Use By' date.
- Coffee beans are best consumed between 5-20 days after the 'Roasted On' date. Ideally only grind directly before the extraction to maximise flavour.
- Buy coffee beans in small batches to reduce the storage time.
- Store coffee beans in a cool, dark and dry container. Vacuum seal if possible.



Care & Cleaning

COLOUR TOUCH SCREEN DISPLAY

Please keep the touch screen dry and clean to ensure that the machine functions properly.

CLEANING CYCLE

- A message for cleaning will be displayed to indicate when a cleaning cycle is required (approx. 200 shots). Or you can start cleaning cycle by choosing 'Clean Cycle' in 'Settings'. The cleaning cycle cleans the shower screen and back-flushes the group head.
- Follow the instruction on the touch screen.

INSTALLING THE WATER FILTER

- Discard the used water filter.
- Wash the filter holder with cold water.
- Insert the filter into the two parts of the filter holder.
- To install the assembled filter holder into the water tank, align the base of the filter holder with the adapter inside the water tank. Push down to lock into place.
- Fill the water tank with cold water before sliding back into position at the back of the machine and locking into place.



NOTE

Visit the Sage website or call Sage Consumer Support to purchase water filters.

CLEANING CONICAL BURRS

Regular cleaning helps the burrs achieve consistent grinding results which is especially important when grinding for espresso.



1 Unlock hopper

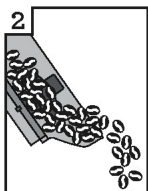

2 Remove beans



3 Replace & lock hopper

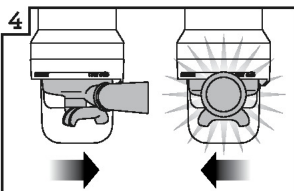

4 Run grinder until empty

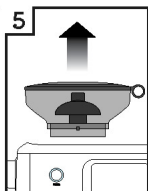

5 Unlock & remove hopper



6 Remove upper burr



7 Clean upper burr with burr brush



8 Clean lower burr with burr brush

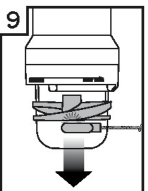

9 Remove tamping fan with tamp removal magnet

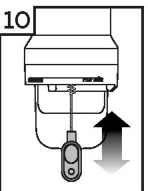

10 Clean grind outlet with grind outlet brush

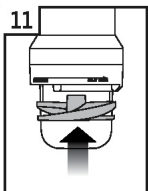

11 Replace tamping fan by hand



12 Push upper burr firmly into position



13 Lock upper burr

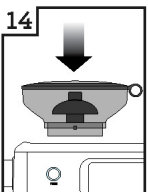

14 Insert hopper



15 Lock hopper

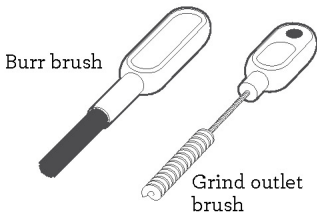

Burr brush

Grind outlet brush

Tamp removal magnet

CLEANING THE STEAM WAND



IMPORTANT

After every use, thoroughly wipe the steam wand and tip with a damp cloth & purge immediately. Failure to clean the steam wand may affect the milk texturing performance.

- If any of the holes in the tip of the steam wand become blocked, ensure the machine stopped steaming and unblock using the steam tip cleaning tool. Even partially blocked holes may affect the ability of the steam wand to produce sufficient foam volume.
- If steam wand remains blocked, remove the tip and soak together with steam wand using the provided steam wand cleaning powder (instructions below). Screw tip back onto the steam wand after rinsing.

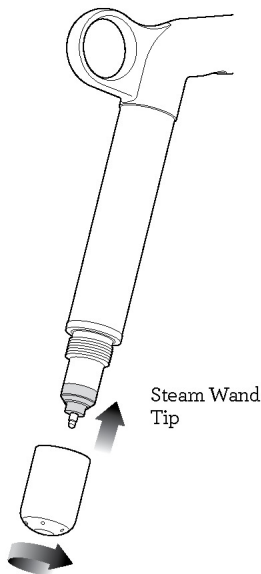

- The steam wand can be left immersed in the milk jug filled with water when not in use to reduce the risk of blockages.

Steam Wand Cleaning Powder

1. Add 1 packet into an empty milk jug.
2. Add 1 cup (8oz/240ml) hot water into milk jug.
3. Remove steam tip and place with steam wand into jug.
4. Leave to soak for 20 minutes.
5. Clean, rinse and replace steam tip. Place wand back into the jug and activate steam for 10 seconds.
6. Allow to soak for 5 minutes.
7. Activate steam several times to purge the steam wand, then rinse the wand thoroughly.
8. Wipe the steam wand dry with a clean cloth.
9. Discard solution & rinse jug thoroughly.



NOTE

If an alternative cleaning solution is used, please follow the instructions specified.

Please ensure the cleaning solution is food safe and suitable for stainless steel and silicon products.

Please ensure the steam wand tip is tightly fastened after cleaning to avoid temp sensing error.

CLEANING THE FILTER BASKET AND PORTAFILTER

- The filter basket and portafilter should be rinsed under hot water after each coffee making session to remove all residual coffee oils.
- If the holes in the filter basket become blocked, dissolve a cleaning tablet in hot water and soak filter basket and portafilter in solution for approx. 20 minutes. Rinse thoroughly.

CLEAR WATER BACKFLUSH

- After each coffee making session we recommend doing a clear water backflush before you turn off the machine. Empty drip tray. Insert the cleaning disc into the filter basket then insert the portafilter into the group head. Touch the 'Brew' button and allow pressure to build for 20 seconds, then touch to stop & release pressure. Repeat this 5 times to purge any fine coffee grounds and residual coffee oils from the brew water paths.

CLEANING THE SHOWER SCREEN

- The group head interior and shower screen should be wiped with a damp cloth to remove any ground coffee particles.
- Periodically, run hot water through the group head with the filter basket and portafilter in place, but without ground coffee. This will remove any residual ground coffee particles from the shower screen.
- If there seems to be stubborn build up on the shower screen, use the allen key to undo the screw in the middle of the shower screen, making note of which side faces into the group head.

CLEANING THE DRIP TRAY & STORAGE TRAY

- The drip tray should be removed, emptied and cleaned after each use.
- Remove grill from the drip tray. Wash the drip tray in warm soapy water.
- The storage tray can be removed and cleaned with a soft, damp cloth (do not use abrasive cleansers, pads or cloths which can scratch the surface).

CLEANING THE OUTER HOUSING & CUP WARMING TRAY

- The outer housing and cup warming tray can be cleaned with a soft, damp cloth. Polish with a soft, dry cloth. Do not use abrasive cleansers, pads or cloths which can scratch the surface.



NOTE

Do not clean any of the parts or accessories in the dishwasher.

DESCALE

- Use this function to access the descale procedure when promoted on screen.
- The machine will enter descale mode if you choose to descale from the pop-up message or if you choose 'Settings' > 'Descale Cycle'. Follow the instruction on the touch screen.
- Please ensure you allow approximately 1.5 hour to complete the entire descale process and follow the step by step instructions. **If you've just finished using your machine, please ensure to turn the machine off and allow to cool for at least 1 hour before starting your descale process.**



NOTE

DO NOT attempt to descale your machine without using the Descale procedure in the Settings menu. Damage to your machine could occur.



Troubleshooting

PROBLEM	POSSIBLE CAUSE	WHAT TO DO
Grinder Motor starts but no ground coffee coming from grind outlet	<ul style="list-style-type: none">• No coffee beans in bean hopper.• Grinder/bean hopper is blocked.• Coffee bean may have become stuck in hopper.	<ul style="list-style-type: none">• Fill bean hopper with fresh coffee beans.• Remove bean hopper. Inspect bean hopper & grinding burrs for blockage. Replace parts and try again.
Grinder Motor starts but operates with a loud 'clicking' noise	<ul style="list-style-type: none">• Grinder is blocked with foreign item or chute is blocked.• Moisture clogging grinder.	<ul style="list-style-type: none">• Remove bean hopper, inspect burrs & remove any foreign body.• Clean the burrs and grind outlet, see page 20.• Leave burrs to dry thoroughly before re-assembling. It is possible to use a hair dryer to blow air into the burr area to quicken the drying process.
Unable to lock bean hopper into position	<ul style="list-style-type: none">• Coffee beans obstructing bean hopper locking device.	<ul style="list-style-type: none">• Remove bean hopper. Clear coffee beans from top of burrs. Re-lock bean hopper into position.
Portafilter overfills	<ul style="list-style-type: none">• Tamping fan was removed for cleaning and not replaced.	<ul style="list-style-type: none">• Check that the tamping fan is in position and mounted correctly to the drive shaft, see page 16.
Grinder Emergency stop?		<ul style="list-style-type: none">• Rotate the portafilter to the left to stop the auto grind, dose & tamp function.• Unplug power cord from power outlet.
Grinder running continuously	<ul style="list-style-type: none">• No beans in hopper.	<ul style="list-style-type: none">• Fill hopper with beans.• Rotate the portafilter to the left to stop the auto grind, dose & tamp function.
	<ul style="list-style-type: none">• Tamping fan has been removed.	<ul style="list-style-type: none">• Check that the tamping fan is in position and mounted correctly to the drive shaft, see page 16.

PROBLEM	POSSIBLE CAUSE	WHAT TO DO
Espresso runs out around the edge of the portafilter	<ul style="list-style-type: none"> Portafilter not inserted in the group head correctly. 	<ul style="list-style-type: none"> Ensure portafilter is rotated to the right until the handle is past the center and is securely locked in place. Rotating past the centre will not damage the silicone seal.
and/or	<ul style="list-style-type: none"> There are coffee grounds around the filter basket rim. 	<ul style="list-style-type: none"> Clean excess coffee from the rim of the filter basket after grinding to ensure a proper seal in group head.
Portafilter comes out of the group head during an extraction	<ul style="list-style-type: none"> Filter basket rim is wet or underside of portafilter lugs are wet. Wet surfaces reduce the friction required to hold the portafilter in place whilst under pressure during an extraction. 	<ul style="list-style-type: none"> Always ensure filter basket and portafilter are dried thoroughly before filling with coffee, tamping and inserting into the group head.
Issues with the Auto Start feature	<ul style="list-style-type: none"> Clock not set or clock is set with incorrect time. 	<ul style="list-style-type: none"> Check that the clock and Auto Start time have been programmed correctly.
Operation Error message on the touch screen	<ul style="list-style-type: none"> A major fault has occurred and machine cannot operate. 	<ul style="list-style-type: none"> Contact Sage Customer Service Centre.
Pumps continue to operate / Steam is very wet / Hot water outlet leaks	<ul style="list-style-type: none"> Using highly filtered, demineralised or distilled water which is affecting how the machine is designed to function. 	<ul style="list-style-type: none"> We recommend using cold, filtered water. We do not recommend using water with no/low mineral content such as highly filtered, demineralised or distilled water. If the problem persists, contact Sage Consumer Support.

PROBLEM	POSSIBLE CAUSE	WHAT TO DO
Water does not flow from the group head	<ul style="list-style-type: none"> Machine has not reached operating temperature. 	<ul style="list-style-type: none"> Allow time for the machine to reach operating temperature.
	<ul style="list-style-type: none"> Water tank is empty. 	<ul style="list-style-type: none"> Fill tank. Prime the system by: <ol style="list-style-type: none"> 1) Touching the 'Brew' button to run water through the group head for 30 seconds. 2) Touching 'Hot Water' to run water through the hot water outlet for 30 seconds.
	<ul style="list-style-type: none"> Water tank not fully inserted & locked. 	<ul style="list-style-type: none"> Push water tank in fully and lock latch closed.
Display says "Water tank empty" but water tank is full	<ul style="list-style-type: none"> Water tank not fully inserted & locked. 	<ul style="list-style-type: none"> Push water tank in fully and lock latch closed.
No steam or hot water	<ul style="list-style-type: none"> Machine is not turned on or up to operating temperature. 	<ul style="list-style-type: none"> Ensure the machine is plugged in and ready for use. You may have a blockage in scale. Please run the descale process.
No hot water	<ul style="list-style-type: none"> Water tank is empty. 	<ul style="list-style-type: none"> Fill water tank.
No steam	<ul style="list-style-type: none"> Steam wand is blocked. 	<ul style="list-style-type: none"> Refer to 'Cleaning the Steam Wand', page 21. You may have a blockage in scale. Please run the descale process.
The machine is 'On' but won't operate		<ul style="list-style-type: none"> Turn machine off. Wait for 60 minutes and turn machine back on. If problem persists, call Sage Consumer Support.
Steam pouring out of group head		<ul style="list-style-type: none"> Turn machine off. Wait for 60 minutes and turn machine back on. If problem persists, call Sage Consumer Support.
Espresso only drips from the portafilter spouts, restricted flow	<ul style="list-style-type: none"> Coffee is ground too finely. 	<ul style="list-style-type: none"> Adjust the grind size to a higher number to make the grind size slightly coarser. You may have a blockage in scale. Please run the descale process.
Espresso flows out too quickly	<ul style="list-style-type: none"> The coffee is ground too coarsely. Coffee beans are stale. 	<ul style="list-style-type: none"> Adjust the grind size to a lower number to make the grind size slightly finer. Use freshly roasted coffee beans with a 'Roasted On' date and consume between 5-20 days after that date.

PROBLEM	POSSIBLE CAUSE	WHAT TO DO
Coffee not hot enough	<ul style="list-style-type: none"> • Cups not pre-heated. 	<ul style="list-style-type: none"> • Rinse cups under hot water outlet and place on cup warming tray.
	<ul style="list-style-type: none"> • Milk not hot enough (if making cappuccino or latté etc). 	<ul style="list-style-type: none"> • Increase the milk temperature in settings menu.
No crema	<ul style="list-style-type: none"> • Coffee beans are stale. 	<ul style="list-style-type: none"> • Use freshly roasted coffee beans with a 'Roasted On' date and consume between 5-20 days after that date.
Not enough milk texture	<ul style="list-style-type: none"> • Steam wand is blocked. 	<ul style="list-style-type: none"> • Refer to 'Cleaning the Steam Wand', page 21. • You may have a blockage in scale. Please run the descale process.
		<ul style="list-style-type: none"> • Different brands and types of milk and milk alternatives will texture differently. You may need to adjust the froth level accordingly.
Too much coffee extracted	<ul style="list-style-type: none"> • Coffee is ground too coarsely. • Shot duration/ volume needs to be adjusted. 	<ul style="list-style-type: none"> • Adjust the grind size to a lower number to make the grind size slightly finer. • Customise extraction time by touching the 'Single'/Double' button.
Not enough coffee extracted	<ul style="list-style-type: none"> • Coffee is ground too finely. • Shot duration/ volume needs to be adjusted. 	<ul style="list-style-type: none"> • Adjust the grind size to a higher number to make the grind size slightly coarser. • Customise extraction time by touching the 'Single'/Double' button.
Amount of coffee extracted has changed, but all settings are the same.	<ul style="list-style-type: none"> • As coffee beans age, the extraction rate changes and can affect the shot volume. 	<ul style="list-style-type: none"> • Adjust the grind size to a lower number to make the grind size slightly finer. • Customise extraction time by touching the 'Single'/Double' button. • Use freshly roasted coffee beans with a 'Roasted On' date and consume between 5-20 days after that date.



Notes